

FERRI®

www.ferri-america.com

















TA

TD

Boom mowers

• Agriculture • Green areas • Tractors from 20 to 70 HP

TA 26  20 to 35 HP  8'10"
TA 32  25 to 40 HP  10'6"
TAR 32  25 to 40 HP  10'6"

TD 37  40 to 60 HP  12'2"
TDR 37  40 to 60 HP  12'2"
TD 42  50 to 70 HP  13'10"
TDR 42  50 to 70 HP  13'10"

Distributed by: J. S. Woodhouse Co., Inc.
1314 Union St
West Springfield, MA 01089

Phone: 413-739-5607
Fax: 413-732-3786
email: info@jswoodhouse.com
website: www.jswoodhouse.com

TA

TD

- *Totally independent hydraulics*
- *FLOATING head system*
- *Reversible rotor by cable*
- *Mechanical breakaway*
- *PTO shaft*
- *Gearbox and pumps directly connected to PTO for TA26*
- *Stabilizer to the tractor (Optional TA-TAR32 and TD only)*

TA 26



TA 32



TAR

Versions for reversible drive

TDR



TD 37



TD 42



Distributed by: J. S. Woodhouse Co., Inc.
1314 Union St
West Springfield, MA 01089

Phone: 413-739-5607
Fax: 413-732-3786
email: info@jswoodhouse.com
website: www.jswoodhouse.com

Boom mowers

• Agriculture • Green areas • Tractors from 20 to 70 HP



Floating head.



Transport position.



Front guard.



Adjustable rear roller.



Tractor stabilizers (optional).



Totally independent hydraulics.



Articulated "Y" flails for: grass and bushes (TA). Max cut 1'



Articulated "Y" flails for: grass and bushes (TD). Max cut 1'



Oil cooler with thermostat (optional TA32-TAR32).



Oil cooler with thermostat (optional TD-TDF).

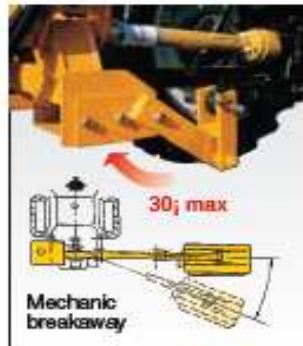

Mechanic breakaway



Mono lever electric controls "Soft Start/Stop" (Full Electra version).

FERRI

Distributed by: J. S. Woodhouse Co., Inc.
1314 Union St
West Springfield, MA 01089

Phone: 413-739-5607
Fax: 413-732-3786
email: info@jswoodhouse.com
website: www.jswoodhouse.com



Boom mowers

• Agriculture • Green areas • Tractors from 20 to 70 HP



Equipment	TA	TD
Rotating head	●	●
Cable controls	●	●
Mono lever electric controls "Soft Start/Stop" (only Full Electra version)	●	●
Mechanical breakaway	●	●
Totally independent hydraulics	●	●
Oil cooler with thermostat	□	□
Direct drive to rotor	●	●
Reversible rotor	●	●
Front and rear guard	●	●
Rear adjustable roller	●	●
Tractor stabilizers	□*	□
DELTA' top link	□	□

● Standard □ Optional

*TA-TAR 32 only

Working positions

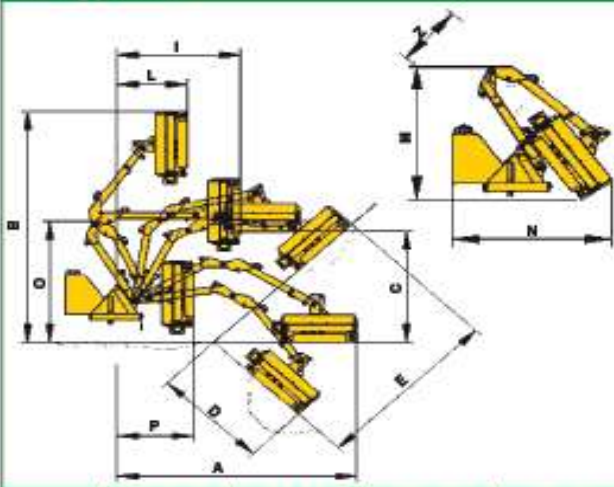

		TA 26	TA 32 TAR 32	TD 37 TDR 37	TD 42 TDR 42
A	ft	8'10"	10'6"	12'2"	13'10"
B	ft	10'2"	12'0"	12'9"	14'10"
C	ft	4'11"	6'11"	6'7"	7'11"
D	ft	4'7"	6'3"	7'7"	8'6"
E	ft	7'3"	9'2"	10'8"	12'4"
I	ft	4'7"	5'3"	5'3"	5'11"
L	ft	2'7"	2'11"	2'11"	2'11"
M	ft	4'7"	5'7"	5'7"	6'7"
N	ft	4'7"	4'7"	4'11"	4'11"
O	ft	5'3"	6'7"	6'7"	7'7"
P	ft	2'11"	2'11"	3'11"	4'3"
Z	ft	2'2"	2'2"	2'4"	2'4"

Technical specifications

Model	TA26	TA32 TAR32	TD37 TDR37	TD42 TDR42
Weight	lbs 568	725	968	1000
Oil capacity	gal 12,4	15,3	19,5	19,5
Three point linkage	Cat. 0-I	I	I-II	I-II
Pto speed	RPM 540	540/1000*	540	540/1000*
Fall head	TME 80	TME 80	TIL 100	TIL 100
Power available to rotor	HP 13	18	18	18
Hydraulic engine power	HP max. 20	29	29	29

*TAR32 / TDR42 only 1000 RPM

Technical specifications of fall head

Model	TME 80	TIL 100
Width of cut	in 32"	39"
Rotor speed	RPM 3000	3000
Blade tip speed	ft/sec 177	177
Fall head angle	190°	190°
Articulated "Y" blades	No. 40	40

Tractors (recommended feature)

HP Tractor	Tractor HP (20, 30, 40, 50, 60, 70)						Min. weight	
	20	30	40	50	60	70	lbs	ft
TA 26	[Bar chart showing compatibility from 20 to 40 HP]						1540	3' 9"
TA-TAR 32	[Bar chart showing compatibility from 30 to 40 HP]						1980	3' 11"
TD-TDR 37	[Bar chart showing compatibility from 40 to 60 HP]						3740	4' 11"
TD-TDR 42	[Bar chart showing compatibility from 50 to 70 HP]						4400	5' 7"

Accessories

CS 150
Max cut 1/2".
Width of cut 59".



DeltaD top link.



All data subject to change.

TAR TD37 & TDR 07 10/11

camp@ferrri.com 62011

Distributed by: J. S. Woodhouse Co., Inc.
1314 Union St
West Springfield, MA 01089

Phone: 413-739-5607
Fax: 413-732-3786
email: info@jswoodhouse.com
website: www.jswoodhouse.com